

# SDI Video Optical Modules Small Form Pluggable



## Features

- 1310 and 1550 nm single mode, 50 Mb/s to 2.97 Gb/s
- SD, ED, HD, and 3G SDI for all video resolutions
- One-way transmitters or receivers, and 2-way transceivers
- 3 Gb/s data rate with 1080p video resolution up to 40 km
- Duplex LC connector, Z-axis hot pluggable

## Applications

- ✓ Serial Digital Interface (SDI) standard
- ✓ SMPTE 297-2006 compatible electrical-optical interface
- ✓ Remote digital display systems
- ✓ Remote security surveillance
- ✓ Professional video broadcast



**SDI Video SFP**

## Products Selection Guide

Part Number *	Wavelength	Data Rate	Power Budget	Distance**	Temp. Range
<b>Dual-Channel Transmitter</b>					
SDI-2970LX-2T2K	1310 nm	2.97 Gb/s	> -8dB (TX)	2 km	0 – 70°C
SDI-2970LX-2T20K	1310 nm	2.97 Gb/s	> -6dB (TX)	20 km	0 – 70°C
SDI-2970LX-2T40K	1310 nm	2.97 Gb/s	> -2dB (TX)	40 km	0 – 70°C
SDI-2970EX-2T40K	1550 nm	2.97 Gb/s	> -2dB (TX)	40 km	0 – 70°C
<b>Dual-Channel Receiver</b>					
SDI-2970EX-2R40K	1260-1580 nm	2.97 Gb/s	> -22 dB (RX)	40 km	0 – 70°C
<b>Single-Channel Transceiver</b>					
SDI-2970LX-TR2K	1310 nm	2.97 Gb/s	> 14 dB	2 km	0 – 70°C
SDI-2970LX-TR20K	1310 nm	2.97 Gb/s	> 16 dB	20 km	0 – 70°C
SDI-2970LX-TR40K	1310 nm	2.97 Gb/s	> 20 dB	40 km	0 – 70°C
SDI-2970EX-TR40K	1550 nm	2.97 Gb/s	> 20 dB	40 km	0 – 70°C

\*: Add "-T" in the Part Number for products with extended temperature range -40–85 °C. For example, SDI-2970LX-2T2K-T.

\*\* : The indicated distance is for reference only, not guaranteed specifications. The actual transmission distance depends on system configuration and power budget. For single mode fibers, the typical loss is 0.25 dB/km @ 1550 nm and 0.35 dB/km @ 1310 nm.

**U.S.A. Office: Optix Communications, Inc.**

17901 Von Karman Avenue, Suite 600,  
Irvine, CA 92614

Tel: (949) 679-5712 Fax: (949) 420-2134

<http://www.OptixCom.com>

<http://www.OpticalTransceiver.com>

Email: [Support@OptixCom.com](mailto:Support@OptixCom.com)

**Germany Office: OptixCom GmbH**

Freiherr vom Stein Strasse 19, 60323  
Frankfurt am Main, Germany

Tel: +49 (0)69 7953-3646

# Dual Channel Transmitters 1310 nm Single Mode, 2-40 km SDI SFP Dual LC Connector



SDI Video Small Form Pluggable (SDI SFP)

## Description

OptixCom's video SFP optical modules are deployed for the increasing demand of high definition video applications over a long distance. The design supports pathological patterns for SD, ED, HD, and 3G SDI (Serial Digital Interface) signals from 50 Mb/s to 3 Gb/s. The high data rate enables crystal clear video resolution with minimum degradation. In addition to standard optical transceiver components used in the module, a micro-controller IC is utilized to process video signals. This electrical-optical interface is also compatible with SMPTE 297-2006 standard and SFP Multi-Source Agreement (MSA) package specifications.

This particular optical module supports two channels of transmitter for one-way video transmission. 1310 nm laser is used with a typical transmission distance of 2-40 km. This product is RoHS compliant and typical power consumption is < 1.7 W.



Lead-Free

**SDI-2970LX-2TXXK**  
(XX = 2, 20, 40)

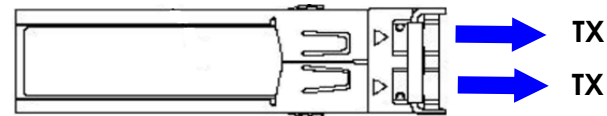

## Key Features

- 1310 nm single mode
- Dual transmitter channels
- 50 Mb/s – 3 Gb/s, 2-40 km reach
- SMPTE 297-2006 compatible
- Support SMPTE 424M/292M/297M/259M
- Duplex LC connector optical interface
- Single 3.3 V power supply
- Z-axis hot pluggable
- SFF-8472 MSA Compliant
- RoHS compliant

## Applications

- ✓ Serial Digital Interface (SDI) standard
- ✓ SMPTE 297-2006 compatible electrical-optical interface
- ✓ Remote digital display systems or security surveillance
- ✓ Professional video broadcast
- ✓ Digital cinema system

## Ordering Information

**Part Number:** SDI-2970LX-2TXXK

### Description:

1310 nm, 50 Mb/s to 2.97 Gb/s, single mode, SDI video SFP dual channel transmitters, XX km reach, 0-70°C

**XX = 2, 20, 40**

## Operating Conditions

Parameter	Min.	Typical	Max.	Units
Operate Temperature	0	25	70	°C
Data Rate	50	2970	3000	Mb/s
Supply Voltage	3.15	3.3	3.45	V
Supply Current	---	---	500	mA

(XX = 2, 20, 40)

### Absolute Maximum Ratings

Parameter	Symbol	Min.	Max.	Units
Storage Temperature	$T_{st}$	-40	85	°C
Humidity	$R.H.$	---	85	%
Soldering Temperature (10 sec. on leads)	$T_{sd}$	---	260	°C

### Transmitter Electro-Optical Characteristics

Parameter	Symbol	Min.	Typical	Max.	Units
Differential Input Voltage <sup>1</sup>	$\Delta V_i$	0.4	---	1.8	V
Differential Input Impedance <sup>2</sup>	$Z$	90	100	110	ohm
Optical Output Power (2 km) <sup>3</sup>	$P_o$	-8	-3	0	dBm
Optical Output Power (20 km) <sup>3</sup>	$P_o$	-6	-2	0	dBm
Optical Output Power (40 km) <sup>3</sup>	$P_o$	-2	0	+3	dBm
Optical Wavelength	$\lambda_o$	1260	1310	1360	nm
Spectral Width (-20 dB)	$\Delta\lambda$	---	---	1	nm
Side Mode Suppression Ratio	$SMSR$	30	---	---	dB
Extinction Ratio	$ET$	5	8	---	dB
Rise/Fall Time (20% - 80%)	SD-SDI	---	---	1500	ps
	HD-SDI	$T_r/T_f$	---	270	
	3G-SDI	---	---	135	
Total Jitter PRBS & Color Bar	SD-SDI	---	70	200	ps
	HD-SDI	$T_j$	---	135	
	3G-SDI	---	70	100	
Total Jitter Pathological	SD-SDI	---	200	300	ps
	HD-SDI	$T_j$	---	115	
	3G-SDI	---	120	---	

Notes:

1. Applied to AC LVPECL I/O coupling. See the design guide for proper termination.
2. Single ended will be 50 ohm for each signal line.
3. Output of coupling optical power into 9/125  $\mu$ m SMF.

**Class 1 Laser Product**  
Complies with  
21 CFR 1040.10 and 1040.11



(XX = 2, 20, 40)

**Transmitter Electro-Optical Characteristics (Cont'd)**

Parameter	Symbol	Min.	Typical	Max.	Units
TX Disable Voltage – High	$V_{DH}$	2.0	---	$V_{CC}$	V
TX Disable Voltage - Low	$V_{DL}$	0	---	0.8	V
TX Fault Output - High	$V_{FH}$	2.0	---	$V_{CC}$	V
TX Fault Output - Low	$V_{FL}$	0	---	0.8	V
TX Disable Assert Time	$T_{ass}$	---	---	10	$\mu$ s
TX Disable Deassert Time	$T_{disass}$	---	---	1.0	ms
Serial ID Clock Rate	$f_c$	---	---	280	kHz
Time to Initialize	$T_{as}$	---	---	300	ms
TX Fault from Fault to Assertion	$T_{fault}$	---	---	100	$\mu$ s
TX Disable Time to Start Reset	$T_{reset}$	10	---	---	$\mu$ s

**PIN Assignment and Description**

**Top of Board**

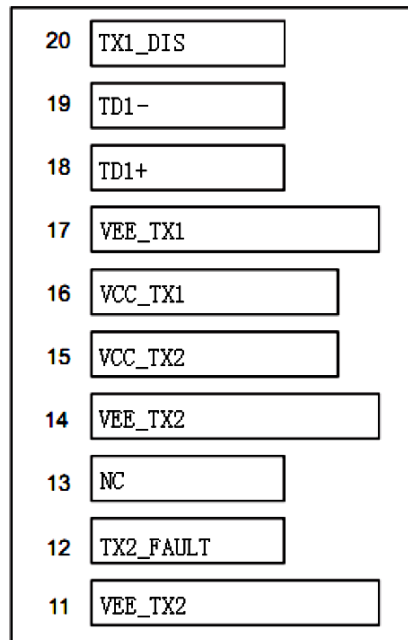

**Bottom of Board**

(as viewed through top of board)

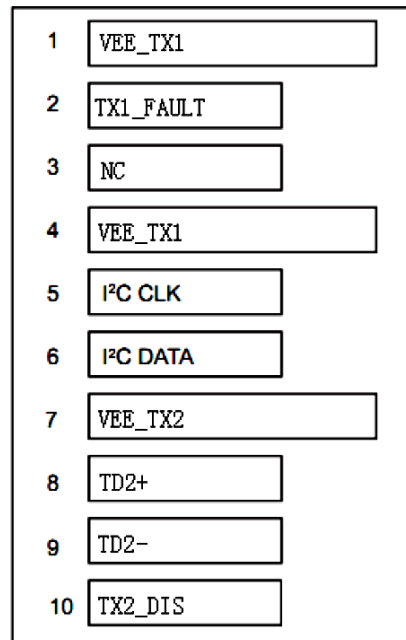

Class 1 Laser Product  
Complies with  
21 CFR 1040.10 and 1040.11



# Dual Channel Transmitters 1550 nm Single Mode, 40 km SDI SFP Dual LC Connector



SDI Video Small Form Pluggable (SDI SFP)

## Description

OptixCom's video SFP optical modules are deployed for the increasing demand of high definition video applications over a long distance. The design supports pathological patterns for SD, ED, HD, and 3G SDI (Serial Digital Interface) signals from 50 Mb/s to 3 Gb/s. The high data rate enables crystal clear video resolution with minimum degradation. In addition to standard optical transceiver components used in the module, a micro-controller IC is utilized to process video signals. This electrical-optical interface is also compatible with SMPTE 297-2006 standard and SFP Multi-Source Agreement (MSA) package specifications.

This particular optical module supports two channels of transmitter for one-way video transmission. 1550 nm DFB laser is used with a typical transmission distance of 40 km. This product is RoHS compliant and typical power consumption is < 1.7 W.



Lead-Free

## SDI-2970EX-2T40K

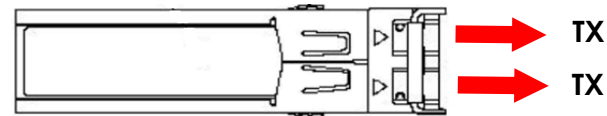

## Key Features

- 1550 nm single mode
- Dual transmitter channels
- 50 Mb/s – 3 Gb/s, 40 km reach
- SMPTE 297-2006 compatible
- Support SMPTE 424M/292M/297M/259M
- Duplex LC connector optical interface
- Single 3.3 V power supply
- Z-axis hot pluggable
- SFF-8472 MSA Compliant
- RoHS compliant

## Applications

- ✓ Serial Digital Interface (SDI) standard
- ✓ SMPTE 297-2006 compatible electrical-optical interface
- ✓ Remote digital display systems or security surveillance
- ✓ Professional video broadcast
- ✓ Digital cinema system

## Ordering Information

**Part Number:** SDI-2970EX-2T40K

### Description:

1550 nm, 50 Mb/s to 2.97 Gb/s, single mode, SDI video SFP dual channel transmitters, 40 km reach, 0-70°C

## Operating Conditions

Parameter	Min.	Typical	Max.	Units
Operate Temperature	0	25	70	°C
Data Rate	50	2970	3000	Mb/s
Supply Voltage	3.15	3.3	3.45	V
Supply Current	---	---	500	mA

**U.S.A. Office: Optix Communications, Inc.**

17901 Von Karman Avenue, Suite 600,  
Irvine, CA 92614

Tel: (949) 679-5712 Fax: (949) 420-2134

<http://www.OptixCom.com>  
<http://www.OpticalTransceiver.com>  
Email: [Support@OptixCom.com](mailto:Support@OptixCom.com)

**Germany Office: OptixCom GmbH**

Freiherr vom Stein Strasse 19, 60323  
Frankfurt am Main, Germany

Tel: +49 (0)69 7953-3646

**Absolute Maximum Ratings**

Parameter	Symbol	Min.	Max.	Units
Storage Temperature	$T_{st}$	-40	85	°C
Humidity	$R.H.$	---	85	%
Soldering Temperature (10 sec. on leads)	$T_{sd}$	---	260	°C

**Transmitter Electro-Optical Characteristics**

Parameter	Symbol	Min.	Typical	Max.	Units
Differential Input Voltage <sup>1</sup>	$\Delta V_i$	0.4	---	1.8	V
Differential Input Impedance <sup>2</sup>	$Z$	90	100	110	ohm
Optical Output Power (40 km) <sup>3</sup>	$P_o$	-2	0	+3	dBm
Optical Wavelength	$\lambda_o$	1480	1550	1580	nm
Spectral Width (-20 dB)	$\Delta\lambda$	---	---	1	nm
Side Mode Suppression Ratio	SMSR	30	---	---	dB
Extinction Ratio	$ET$	5	8	---	dB
Rise/Fall Time (20% - 80%)	SD-SDI	---	---	1500	ps
	HD-SDI	---	---	270	
	3G-SDI	---	---	135	
Total Jitter PRBS & Color Bar	SD-SDI	---	70	200	ps
	HD-SDI	---	50	135	
	3G-SDI	---	70	100	
Total Jitter Pathological	SD-SDI	---	200	300	ps
	HD-SDI	---	115	---	
	3G-SDI	---	120	---	

Notes:

1. Applied to AC LVPECL I/O coupling. See the design guide for proper termination.
2. Single ended will be 50 ohm for each signal line.
3. Output of coupling optical power into 9/125  $\mu$ m SMF.

**Class 1 Laser Product  
Complies with  
21 CFR 1040.10 and 1040.11**



**Transmitter Electro-Optical Characteristics (Cont'd)**

Parameter	Symbol	Min.	Typical	Max.	Units
TX Disable Voltage – High	$V_{DH}$	2.0	---	$V_{CC}$	V
TX Disable Voltage - Low	$V_{DL}$	0	---	0.8	V
TX Fault Output - High	$V_{FH}$	2.0	---	$V_{CC}$	V
TX Fault Output - Low	$V_{FL}$	0	---	0.8	V
TX Disable Assert Time	$T_{ass}$	---	---	10	$\mu$ s
TX Disable Deassert Time	$T_{disass}$	---	---	1.0	ms
Serial ID Clock Rate	$f_c$	---	---	280	kHz
Time to Initialize	$T_{as}$	---	---	300	ms
TX Fault from Fault to Assertion	$T_{fault}$	---	---	100	$\mu$ s
TX Disable Time to Start Reset	$T_{reset}$	10	---	---	$\mu$ s

**PIN Assignment and Description**

**Top of Board**

20	TX1_DIS
19	TD1-
18	TD1+
17	VEE_TX1
16	VCC_TX1
15	VCC_TX2
14	VEE_TX2
13	NC
12	TX2_FAULT
11	VEE_TX2

**Bottom of Board  
(as viewed through top of board)**

1	VEE_TX1
2	TX1_FAULT
3	NC
4	VEE_TX1
5	I <sup>2</sup> C CLK
6	I <sup>2</sup> C DATA
7	VEE_TX2
8	TD2+
9	TD2-
10	TX2_DIS

Class 1 Laser Product  
Complies with  
21 CFR 1040.10 and 1040.11



# Dual Channel Receivers 1260 - 1580 nm Single Mode SDI SFP Dual LC Connector

## Description

OptixCom's video SFP optical modules are deployed for the increasing demand of high definition video applications over a long distance. The design supports pathological patterns for SD, ED, HD, and 3G SDI (Serial Digital Interface) signals from 50 Mb/s to 3 Gb/s. The high data rate enables crystal clear video resolution with minimum degradation. In addition to standard optical transceiver components used in the module, a micro-controller IC is utilized to process video signals. This electrical-optical interface is also compatible with SMPTE 297-2006 standard and SFP Multi-Source Agreement (MSA) package specifications.

This particular optical module supports two channels of receiver for one-way video receiving. The module uses PIN photodiode for 1260-1580 nm incoming optical wavelength with -22 dB of sensitivity and 40 km reach typically. This product is RoHS compliant and typical power consumption is < 0.5 W.



Lead-Free

## SDI-2970EX-2R40K

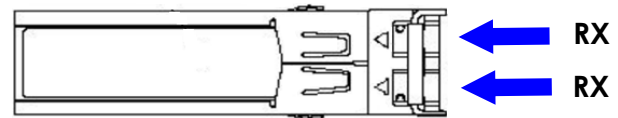

## Key Features

- 1260 nm - 1580 nm single mode
- Dual receiver channels
- 50 Mb/s – 3 Gb/s, -22 dB sensitivity
- SMPTE 297-2006 compatible
- Support SMPTE 424M/292M/297M/259M
- Duplex LC connector optical interface
- Single 3.3 V power supply
- Z-axis hot pluggable
- SFF-8472 MSA Compliant
- RoHS compliant

## Applications

- ✓ Serial Digital Interface (SDI) standard
- ✓ SMPTE 297-2006 compatible electrical-optical interface
- ✓ Remote digital display systems or security surveillance
- ✓ Professional video broadcast
- ✓ Digital cinema system

## Ordering Information

**Part Number:** SDI-2970EX-2R40K

### Description:

1260 nm – 1580 nm, 50 Mb/s to 2.97 Gb/s, single mode, SDI video SFP dual channel receivers, 40 km reach, 0-70°C

## Operating Conditions

Parameter	Min.	Typical	Max.	Units
Operate Temperature	0	25	70	°C
Data Rate	50	2970	3000	Mb/s
Supply Voltage	3.15	3.3	3.45	V
Supply Current	---	---	150	mA



**Absolute Maximum Ratings**

Parameter	Symbol	Min.	Max.	Units
Storage Temperature	$T_{st}$	-40	85	°C
Humidity	$R.H.$	---	85	%
Soldering Temperature (10 sec. on leads)	$T_{sd}$	---	260	°C

**Receiver Electro-Optical Characteristics**

Parameter	Symbol	Min.	Typical	Max.	Units
Differential Output Voltage <sup>1</sup>	$\Delta V_i$	0.6	0.8	1.0	V
Differential Impedance <sup>2</sup>	$Z$	90	100	110	ohm
RX Signal Loss – Deasserted	$P_{RL-}$	-29	---	---	dBm
RX Signal Loss – Asserted	$P_{RL+}$	---	---	-22	dBm
Receiver Overload	$P_{max}$	+0	---	---	dBm
Optical Wavelength	$\lambda_o$	1260	---	1580	nm
Signal Detect Hysteresis	$P_{RL+} - P_{RL-}$	1	---	---	dB
Receiver Sensitivity (PBRs) <sup>3</sup>	SD-SDI	---	---	-25	dBm
	HD-SDI	$P_I$	---	-23	
	3G-SDI	---	---	-22	
Receiver (Pathological) <sup>3</sup>	SD-SDI	---	---	-25	dBm
	HD-SDI	$P_I$	---	-23	
	3G-SDI	---	---	-22	
Rise/Fall Time (20% - 80%)	SD-SDI	---	---	1500	ps
	HD-SDI	$T_r/T_f$	---	270	
	3G-SDI	---	---	135	

Notes:

1. Applied to AC LVPECL I/O coupling. See the design guide for proper termination.
2. Single ended will be 50 ohm for each signal line.
3. Test at 3 Gb/s, 2<sup>7</sup> – 1 PRBS data pattern, and > 1x10<sup>-12</sup> of Bit-Error-Rate (BER)

**Class 1 Laser Product  
Complies with  
21 CFR 1040.10 and 1040.11**



**Receiver Electro-Optical Characteristics (Cont'd)**

Parameter	Symbol	Min.	Typical	Max.	Units
Total Jitter PRBS & Color Bar	SD-SDI	---	70	200	ps
	HD-SDI	---	50	135	
	3G-SDI	---	70	100	
Total Jitter Pathological	SD-SDI	---	200	300	ps
	HD-SDI	---	115	---	
	3G-SDI	---	120	---	
RX Signal Loss Output - High	$V_{RL+}$	2.0	---	$V_{CC}$	V
RX Signal Loss Output - Low	$V_{RL-}$	0	---	0.8	V
RX Signal Loss Assert Time	$T_{RL+}$	---	---	100	$\mu$ s
RX Signal Loss Deassert Time	$T_{RL-}$	---	---	100	$\mu$ s

**PIN Assignment and Description**

**Top of Board**

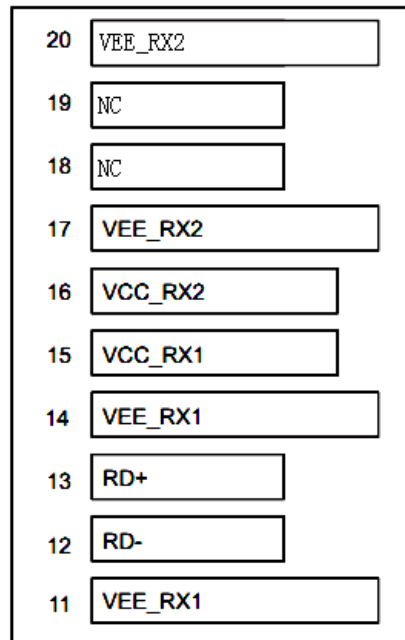

**Bottom of Board**

(as viewed through top of board)

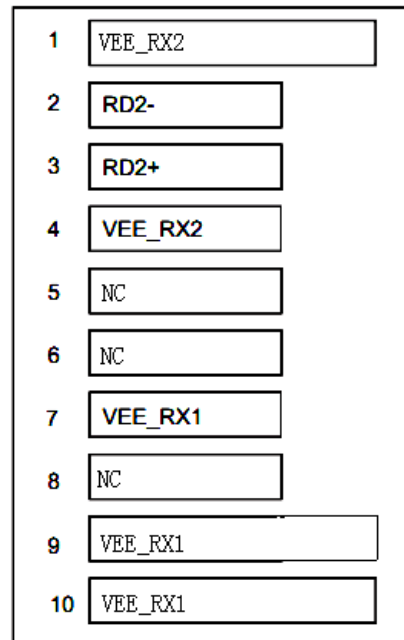

Class 1 Laser Product  
Complies with  
21 CFR 1040.10 and 1040.11



# 50 Mb/s - 2.97 Gb/s Transceivers 1310 nm, Single Mode, 2-40 km SDI SFP Dual LC Connector



SDI Video Small Form Pluggable (SDI SFP)

## Description

OptixCom's advanced video SFP optical transceivers are deployed for the increasing demand of high definition video applications over a long distance. The design supports pathological patterns for SD, ED, HD, and 3G SDI (Serial Digital Interface) signals from 50 Mb/s to 3 Gb/s. The high data rate enables crystal clear video resolution with minimum degradation. In addition to standard optical transceiver components used in the module, a micro-controller IC is utilized to process video signals. This electrical-optical interface is also compatible with SMPTE 297-2006 standard and SFP Multi-Source Agreement (MSA) package specifications.

This particular transceiver module supports a two-way optical video link. The transceiver has >14 dB power budget for 2 km, >16 dB for 20 km, and >20 dB for 40 km of transmission distance with standard single mode fibers. This product is RoHS compliant and typical power consumption is < 1.5 W.



Lead-Free

**SDI-2970LX-TRXXK**  
(XX = 2, 20, 40)

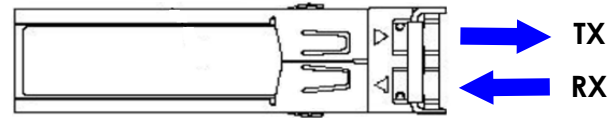

## Key Features

- 1310 nm single mode optical transceiver
- 50 Mb/s – 3 Gb/s; SMPTE 297-2006 compatible
- 14–20 dB power budget for 2–40 km distance
- Support SMPTE 424M/292M/297M/259M
- Duplex LC connector optical interface
- Single 3.3V power supply
- Z-axis hot pluggable
- SFF-8472 MSA Compliant
- RoHS compliant

## Applications

- ✓ Serial Digital Interface (SDI) standard
- ✓ SMPTE 297-2006 compatible electrical-optical interface
- ✓ Remote digital display systems or security surveillance
- ✓ Professional video broadcast
- ✓ Digital cinema system

## Ordering Information

**Part Number:** SDI-2970LX-TRXXK

### Description:

1310 nm, 50 Mb/s to 2.97 Gb/s, single mode, SDI video SFP optical transceivers, XX km reach, 0-70°C

**XX = 2, 20, 40**

## Operating Conditions

Parameter	Min.	Typical	Max.	Units
Operate Temperature	0	25	70	°C
Data Rate	50	2970	3000	Mb/s
Supply Voltage	3.15	3.3	3.45	V
Supply Current	---	---	450	mA

**U.S.A. Office: Optix Communications, Inc.**

17901 Von Karman Avenue, Suite 600,  
Irvine, CA 92614

Tel: (949) 679-5712 Fax: (949) 420-2134

<http://www.OptixCom.com>

<http://www.OpticalTransceiver.com>

Email: [Support@OptixCom.com](mailto:Support@OptixCom.com)

**Germany Office: OptixCom GmbH**

Freiherr vom Stein Strasse 19, 60323  
Frankfurt am Main, Germany

Tel: +49 (0)69 7953-3646

(XX = 2, 20, 40)

### Absolute Maximum Ratings

Parameter	Symbol	Min.	Max.	Units
Storage Temperature	$T_{st}$	-40	85	°C
Humidity	$R.H.$	---	85	%
Soldering Temperature (10 sec. on leads)	$T_{sd}$	---	260	°C

### Transmitter Electro-Optical Characteristics

Parameter	Symbol	Min.	Typical	Max.	Units
Differential Input Voltage <sup>1</sup>	$\Delta V_i$	0.4	---	1.8	V
Differential Input Impedance <sup>2</sup>	$Z$	90	100	110	ohm
Optical Output Power (2 km) <sup>3</sup>	$P_o$	-8	-3	0	dBm
Optical Output Power (20 km) <sup>3</sup>	$P_o$	-6	-2	0	dBm
Optical Output Power (40 km) <sup>3</sup>	$P_o$	-2	0	+3	dBm
Optical Wavelength	$\lambda_o$	1260	1310	1360	nm
Spectral Width (-20 dB)	$\Delta\lambda$	---	---	1	nm
Side Mode Suppression Ratio	$SMSR$	30	---	---	dB
Extinction Ratio	$ET$	5	8	---	dB
Rise/Fall Time (20% - 80%)	SD-SDI	---	---	1500	ps
	HD-SDI	$T_r/T_f$	---	270	
	3G-SDI	---	---	135	
Total Jitter PRBS & Color Bar	SD-SDI	---	70	200	ps
	HD-SDI	$T_j$	---	135	
	3G-SDI	---	70	100	
Total Jitter Pathological	SD-SDI	---	200	300	ps
	HD-SDI	$T_j$	---	115	
	3G-SDI	---	120	---	

Notes:

1. Applied to AC LVPECL I/O coupling. See the design guide for proper termination.
2. Single ended will be 50 ohm for each signal line.
3. Output of coupling optical power into 9/125  $\mu$ m SMF.

**Class 1 Laser Product  
Complies with  
21 CFR 1040.10 and 1040.11**



(XX = 2, 20, 40)

**Transmitter Electro-Optical Characteristics (Cont'd)**

Parameter	Symbol	Min.	Typical	Max.	Units
TX Disable Voltage – High	$V_{DH}$	2.0	---	$V_{CC}$	V
TX Disable Voltage - Low	$V_{DL}$	0	---	0.8	V
TX Fault Output - High	$V_{FH}$	2.0	---	$V_{CC}$	V
TX Fault Output - Low	$V_{FL}$	0	---	0.8	V
TX Disable Assert Time	$T_{ass}$	---	---	10	$\mu$ s
TX Disable Deassert Time	$T_{disass}$	---	---	1.0	ms
Serial ID Clock Rate	$f_c$	---	---	280	kHz
Time to Initialize	$T_{as}$	---	---	300	ms
TX Fault from Fault to Assertion	$T_{fault}$	---	---	100	$\mu$ s
TX Disable Time to Start Reset	$T_{reset}$	10	---	---	$\mu$ s

**PIN Assignment and Description**

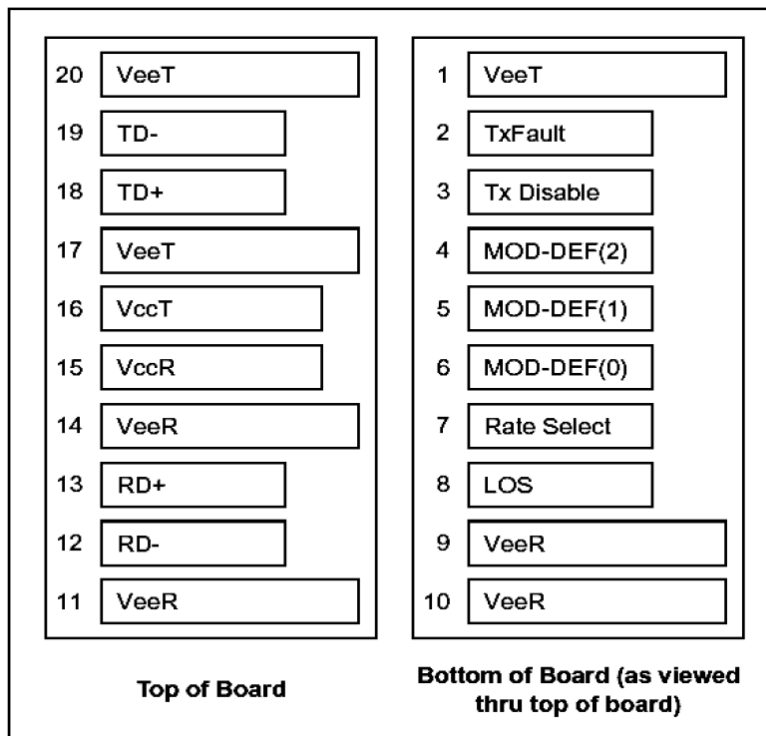

Class 1 Laser Product  
Complies with  
21 CFR 1040.10 and 1040.11



**Receiver Electro-Optical Characteristics**

Parameter	Symbol	Min.	Typical	Max.	Units
Differential Output Voltage <sup>1</sup>	$\Delta V_i$	0.6	0.8	1.0	V
Differential Impedance <sup>2</sup>	Z	90	100	110	ohm
RX Signal Loss – Deasserted	$P_{RL-}$	-29	---	---	dBm
RX Signal Loss – Asserted	$P_{RL+}$	---	---	-22	dBm
Receiver Overload	$P_{max}$	+0	---	---	dBm
Optical Wavelength	$\lambda_o$	1260	---	1580	nm
Signal Detect Hysteresis	$P_{RL+} - P_{RL-}$	1	---	---	dB
Receiver Sensitivity (PBRs) <sup>3</sup>	SD-SDI	---	---	-25	dBm
	HD-SDI	$P_i$	---	-23	
	3G-SDI	---	---	-22	
Receiver (Pathological) <sup>3</sup>	SD-SDI	---	---	-25	dBm
	HD-SDI	$P_i$	---	-23	
	3G-SDI	---	---	-22	
Rise/Fall Time (20% - 80%)	SD-SDI	---	---	1500	ps
	HD-SDI	$T_r/T_f$	---	270	
	3G-SDI	---	---	135	
Total Jitter PRBS & Color Bar	SD-SDI	---	70	200	Ps
	HD-SDI	$T_j$	50	135	
	3G-SDI	---	70	100	
Total Jitter Pathological	SD-SDI	---	200	300	ps
	HD-SDI	$T_j$	115	---	
	3G-SDI	---	120	---	
RX Signal Loss Output - High	$V_{RL+}$	2.0	---	$V_{cc}$	V
RX Signal Loss Output - Low	$V_{RL-}$	0	---	0.8	V
RX Signal Loss Assert Time	$T_{RL+}$	---	---	100	$\mu s$
RX Signal Loss Deassert Time	$T_{RL-}$	---	---	100	$\mu s$

Notes:

1. Applied to AC LVPECL I/O coupling. See the design guide for proper termination.
2. Single ended will be 50 ohm for each signal line.
3. Test at 3 Gb/s, 2<sup>7</sup> - 1 PRBS data pattern, and > 1x10<sup>-12</sup> of Bit-Error-Rate (BER)

**Class 1 Laser Product**  
Complies with  
**21 CFR 1040.10 and 1040.11**



# 50 Mb/s - 2.97 Gb/s Transceivers 1550 nm, Single Mode, 40 km SDI SFP Dual LC Connector



SDI Video Small Form Pluggable (SDI SFP)

## Description

OptixCom's advanced video SFP optical transceivers are deployed for the increasing demand of high definition video applications over a long distance. The design supports pathological patterns for SD, ED, HD, and 3G SDI (Serial Digital Interface) signals from 50 Mb/s to 3 Gb/s. The high data rate enables crystal clear video resolution with minimum degradation. In addition to standard optical transceiver components used in the module, a micro-controller IC is utilized to process video signals. This electrical-optical interface is also compatible with SMPTE 297-2006 standard and SFP Multi-Source Agreement (MSA) package specifications.

This particular transceiver module supports a two-way optical video link. The transceiver has >20 dB power budget for 40 km of transmission distance with standard single mode fibers. This product is RoHS compliant and typical power consumption is < 1.5 W.



Lead-Free

## SDI-2970EX-TR40K

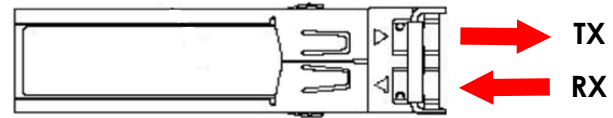

## Key Features

- 1550 nm single mode optical transceiver
- 50 Mb/s – 3 Gb/s; SMPTE 297-2006 compatible
- 20 dB power budget for 40 km distance
- Support SMPTE 424M/292M/297M/259M
- Duplex LC connector optical interface
- Single 3.3V power supply
- Z-axis hot pluggable
- SFF-8472 MSA Compliant
- RoHS compliant

## Applications

- ✓ Serial Digital Interface (SDI) standard
- ✓ SMPTE 297-2006 compatible electrical-optical interface
- ✓ Remote digital display systems or security surveillance
- ✓ Professional video broadcast
- ✓ Digital cinema system

## Ordering Information

**Part Number:** SDI-2970EX-TR40K

### Description:

1310 nm, 50 Mb/s to 2.97 Gb/s, single mode, SDI video SFP optical transceivers, 40 km reach, 0-70°C

## Operating Conditions

Parameter	Min.	Typical	Max.	Units
Operate Temperature	0	25	70	°C
Data Rate	50	2970	3000	Mb/s
Supply Voltage	3.15	3.3	3.45	V
Supply Current	---	---	450	mA

**U.S.A. Office: Optix Communications, Inc.**

17901 Von Karman Avenue, Suite 600,  
Irvine, CA 92614

Tel: (949) 679-5712 Fax: (949) 420-2134

<http://www.OptixCom.com>

<http://www.OpticalTransceiver.com>

Email: [Support@OptixCom.com](mailto:Support@OptixCom.com)

**Germany Office: OptixCom GmbH**

Freiherr vom Stein Strasse 19, 60323  
Frankfurt am Main, Germany

Tel: +49 (0)69 7953-3646

### Absolute Maximum Ratings

Parameter	Symbol	Min.	Max.	Units
Storage Temperature	$T_{st}$	-40	85	°C
Humidity	$R.H.$	---	85	%
Soldering Temperature (10 sec. on leads)	$T_{sd}$	---	260	°C

### Transmitter Electro-Optical Characteristics

Parameter	Symbol	Min.	Typical	Max.	Units
Differential Input Voltage <sup>1</sup>	$\Delta V_i$	0.4	---	1.8	V
Differential Input Impedance <sup>2</sup>	$Z$	90	100	110	ohm
Optical Output Power <sup>3</sup>	$P_o$	-2	0	+3	dBm
Optical Wavelength	$\lambda_o$	1480	1550	1580	nm
Spectral Width (-20 dB)	$\Delta\lambda$	---	---	1	nm
Side Mode Suppression Ratio	$SMSR$	30	---	---	dB
Extinction Ratio	$ET$	5	8	---	dB
Rise/Fall Time (20% - 80%)	SD-SDI	---	---	1500	ps
	HD-SDI	---	---	270	
	3G-SDI	---	---	135	
Total Jitter PRBS & Color Bar	SD-SDI	---	70	200	ps
	HD-SDI	---	50	135	
	3G-SDI	---	70	100	
Total Jitter Pathological	SD-SDI	---	200	300	ps
	HD-SDI	---	115	---	
	3G-SDI	---	120	---	

Notes:

1. Applied to AC LVPECL I/O coupling. See the design guide for proper termination.
2. Single ended will be 50 ohm for each signal line.
3. Output of coupling optical power into 9/125  $\mu$ m SMF.

**Class 1 Laser Product  
Complies with  
21 CFR 1040.10 and 1040.11**





**Transmitter Electro-Optical Characteristics (Cont'd)**

Parameter	Symbol	Min.	Typical	Max.	Units
TX Disable Voltage – High	$V_{DH}$	2.0	---	$V_{CC}$	V
TX Disable Voltage - Low	$V_{DL}$	0	---	0.8	V
TX Fault Output - High	$V_{FH}$	2.0	---	$V_{CC}$	V
TX Fault Output - Low	$V_{FL}$	0	---	0.8	V
TX Disable Assert Time	$T_{ass}$	---	---	10	$\mu$ s
TX Disable Deassert Time	$T_{disass}$	---	---	1.0	ms
Serial ID Clock Rate	$f_c$	---	---	280	kHz
Time to Initialize	$T_{as}$	---	---	300	ms
TX Fault from Fault to Assertion	$T_{fault}$	---	---	100	$\mu$ s
TX Disable Time to Start Reset	$T_{reset}$	10	---	---	$\mu$ s

**PIN Assignment and Description**

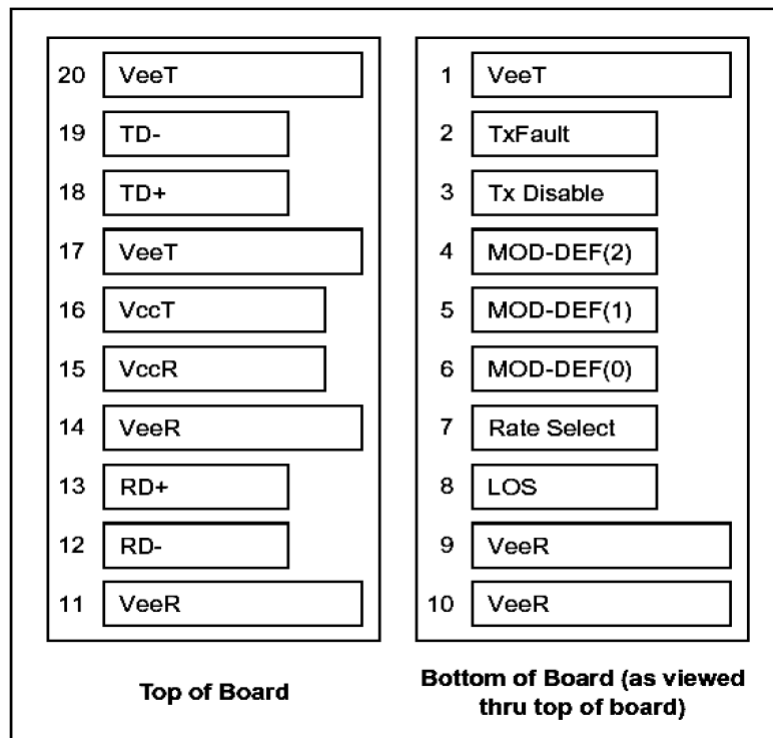

Class 1 Laser Product  
Complies with  
21 CFR 1040.10 and 1040.11



**Receiver Electro-Optical Characteristics**

Parameter	Symbol	Min.	Typical	Max.	Units
Differential Output Voltage <sup>1</sup>	$\Delta V_i$	0.6	0.8	1.0	V
Differential Impedance <sup>2</sup>	Z	90	100	110	ohm
RX Signal Loss – Deasserted	$P_{RL-}$	-29	---	---	dBm
RX Signal Loss – Asserted	$P_{RL+}$	---	---	-22	dBm
Receiver Overload	$P_{max}$	+0	---	---	dBm
Optical Wavelength	$\lambda_o$	1260	---	1580	nm
Signal Detect Hysteresis	$P_{RL+} - P_{RL-}$	1	---	---	dB
Receiver Sensitivity (PBRS) <sup>3</sup>	SD-SDI	---	---	-25	dBm
	HD-SDI	$P_i$	---	-23	
	3G-SDI	---	---	-22	
Receiver (Pathological) <sup>3</sup>	SD-SDI	---	---	-25	dBm
	HD-SDI	$P_i$	---	-23	
	3G-SDI	---	---	-22	
Rise/Fall Time (20% - 80%)	SD-SDI	---	---	1500	ps
	HD-SDI	$T_r/T_f$	---	270	
	3G-SDI	---	---	135	
Total Jitter PRBS & Color Bar	SD-SDI	---	70	200	Ps
	HD-SDI	$T_j$	---	135	
	3G-SDI	---	70	100	
Total Jitter Pathological	SD-SDI	---	200	300	ps
	HD-SDI	$T_j$	---	---	
	3G-SDI	---	120	---	
RX Signal Loss Output - High	$V_{RL+}$	2.0	---	$V_{cc}$	V
RX Signal Loss Output - Low	$V_{RL-}$	0	---	0.8	V
RX Signal Loss Assert Time	$T_{RL+}$	---	---	100	$\mu s$
RX Signal Loss Deassert Time	$T_{RL-}$	---	---	100	$\mu s$

Notes:

1. Applied to AC LVPECL I/O coupling. See the design guide for proper termination.
2. Single ended will be 50 ohm for each signal line.
3. Test at 3 Gb/s, 2<sup>7</sup> – 1 PRBS data pattern, and > 1x10<sup>-12</sup> of Bit-Error-Rate (BER)

**Class 1 Laser Product**  
Complies with  
**21 CFR 1040.10 and 1040.11**

